

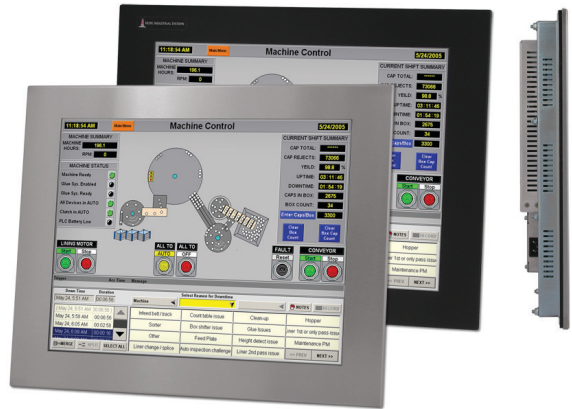

HOPE INDUSTRIAL SYSTEMS



19" PANEL MOUNT INDUSTRIAL MONITOR REVISION F USER MANUAL

Model No. HIS-ML19- __ _ F



Table of Contents

Safety and Regulatory Information	3
FCC Notice	3
Hazardous Locations	4
Waste Electrical and Electronic Equipment Directive (WEEE)	4
Mechanical Drawings	5
Front and Side Views	5
Bottom View	5
Installation Instructions	6
Step 1: Prepare for Installation	6
Step 2: Bench-test Configuration	7
Install Cable Connections	7
Install Touch Screen Driver	8
Step 3: Install into Panel	10
Video Settings	12
Setting the Timing Mode	12
Control Panel Buttons	13
OSD and Power Lock Settings	14
On-Screen Display (OSD) Menus.....	15
Auto Image Adjust Menu	15
Contrast / Brightness Menu.....	16
Input Select Menu	16
Color Adjust Menu	16
Information Menu	17
Manual Image Adjust Menu.....	18
Setup Menu.....	19
Memory Recall Menu	19
Cleaning Instructions	20
Troubleshooting	21
Video Troubleshooting	21
Touch Screen Troubleshooting	23
Specifications	24
Display	24
Electrical	24
Environmental	24
Video	25
Functional	25
Physical	26
Compliances and Certifications	26
Warranty Statement	27



Safety and Regulatory Information



WARNING!

To prevent fire or shock hazard, do not expose live components to rain or moisture. Dangerously high voltages are present inside the unit. Do not disassemble the unit. Refer servicing to qualified personnel only.

This equipment is not intended for use in critical applications where its failure to operate would create immediate life threatening circumstances. Applications including, but not limited to, nuclear reactor control, aerospace navigation systems and life support systems are not appropriate for this product.

This product is intended to be mounted in a suitable cabinet or other enclosure. The NEMA 4, 4X, or 12 ratings are applicable only when properly installed in a like rated enclosure.

To be covered by UL 60950 3rd Edition, the socket-outlet shall be installed near the equipment and shall be easily accessible.

FCC Notice

This equipment has been tested and found to comply with the limits for a Class A digital device, pursuant to Part 15 of the FCC Rules. These limits are designed to provide reasonable protection against harmful interference when the equipment is operated in a commercial environment. This equipment generates, uses, and can radiate radio frequency energy and, if not installed and used in accordance with the instruction manual, may cause harmful interference to radio communications. Operation of this equipment in a residential area is likely to cause harmful interference in which case the user will be required to correct the interference at his own expense. Any changes or modifications not expressly approved by the grantee of this device could void the user's authority to operate the device.

Hazardous Locations

The following applies only to monitors rated for hazardous locations (model numbers HIS-ML19- _ _ HF):

This equipment is suitable for use in Class I, II & III, Division 2, Groups A, B, C, D, F, and G or non-hazardous locations only.

WARNING – EXPLOSION HAZARD – Do not disconnect equipment unless power has been removed or the area is known to be non-hazardous.

WARNING – EXPLOSION HAZARD – Substitution of any components may impair suitability for Class I, II & III, Division 2 Locations.

Waste Electrical and Electronic Equipment Directive (WEEE)

The following information is only for EU-member states:

The mark shown to the right is in compliance with the Waste Electrical and Electronic Equipment Directive 2002/96/EC (WEEE).



The mark indicates the requirement NOT to dispose of the equipment as unsorted municipal waste, but use the return and collection systems according to local law. Users should contact their supplier and check the terms and conditions of the purchase contract. When purchased directly from Hope Industrial Systems, you may contact technical support for disposal arrangements.

Mechanical Drawings

Front and Side Views

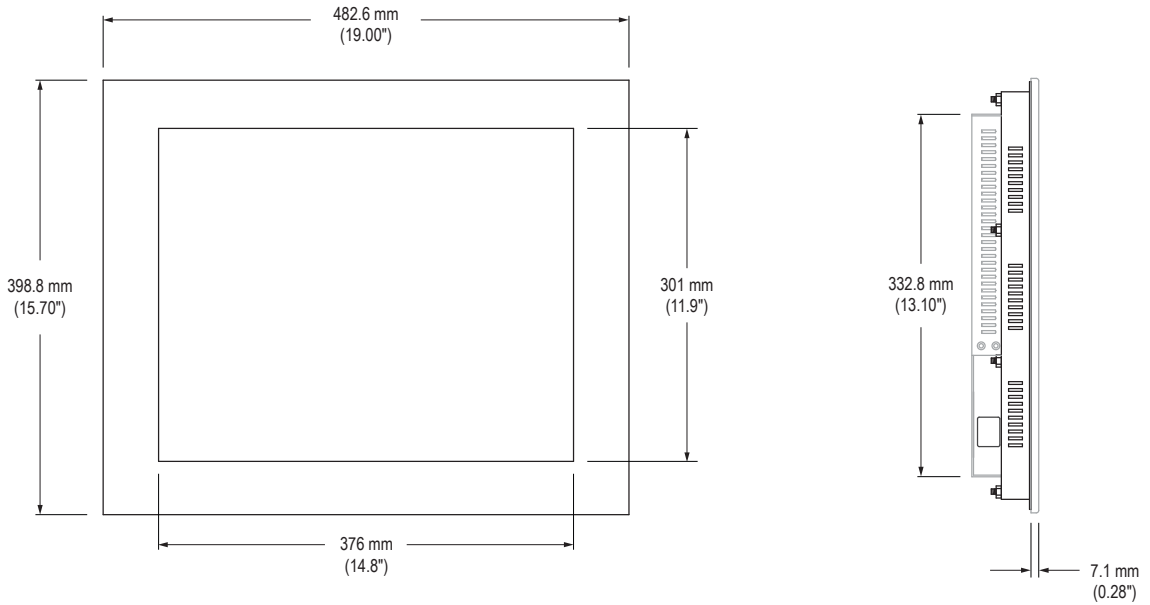

Bottom View

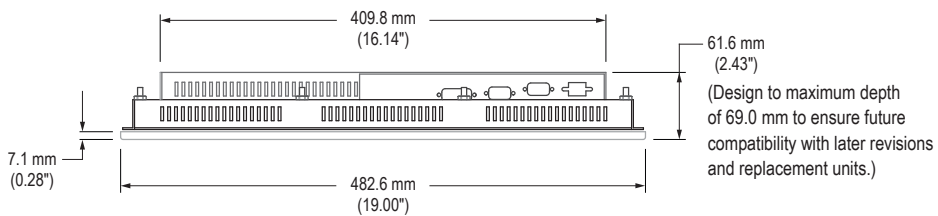

Installation Instructions

Step 1: Prepare for Installation



IMPORTANT!

Perform the following steps **BEFORE** installation of the monitor into the panel.

1. Ensure that sufficient power is available.
2. Ensure that sufficient space is available to allow for proper air flow into and out of the unit.
3. Ensure that the air temperature around the unit (top and bottom) *will not exceed the rated specifications of the unit.*



- ▶ **The maximum rated temperature for the HIS-ML19 is 50°C (122°F).**
 - ▶ **Remember that heat rises – the temperature at the top of the cabinet will be much hotter than at the bottom if air inside the enclosure is not actively circulating. Even in a sealed enclosure, use of a circulation fan can greatly reduce temperature.**
 - ▶ **Also, remember that even though this product is designed to operate at 50°C, the life span of any electronic device is shortened when it is consistently operated at high temperatures. Therefore, it is wise to take steps to keep the temperature of the ambient air around the unit as low as possible.**
4. Ensure that the ambient humidity of the air around the unit *does not exceed the specifications of the unit.*
 - ▶ **The maximum rated humidity for the HIS-ML19 is 90% non-condensing.**

Step 2: Bench-test Configuration

Make sure everything works before installing into the production environment.



TIP!

If using a KVM extender, please refer to the installation instructions included with the KVM extender module. It is particularly important to bench-test the full configuration prior to final installation. This will help to identify and troubleshoot any system issues while configuration changes may still be easily made.

Install Cable Connections

All monitors are shipped with both a 6 ft. VGA video cable and 6 ft. power cable, unless longer cables were ordered in their place. If you ordered a touch screen monitor, you also received a 6 ft. Serial (RS-232) cable and 6 ft. USB cable.

The cable ports are located on the rear of the monitor. Refer to the following diagram and instructions to connect power, video, and touch screen (if applicable) to your monitor.

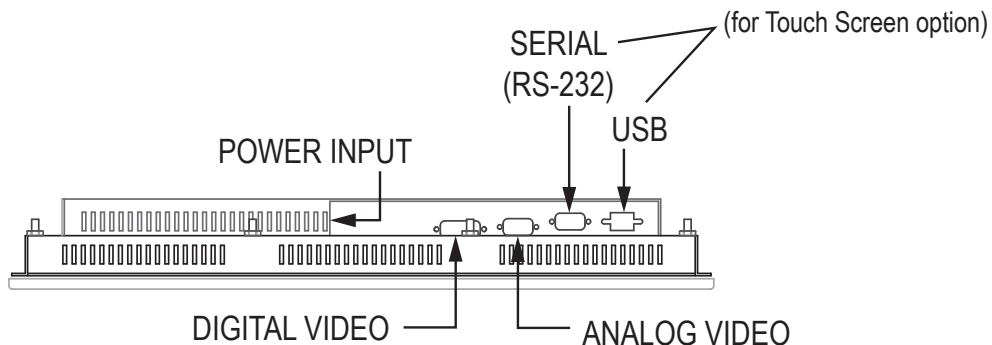

Video Connection

The HIS-ML19 supports analog and digital video.

Analog Video Connection

Connect one end of the VGA video cable to the HD-15 input port on the rear of the monitor. Connect the other end to the analog video output port on the host computer.

Digital Video Connection

Connect one end of the DVI video cable to the DVI-D input port on the rear of the monitor. Connect the other end to the digital video output port on the host computer.

Power Connection

The HIS-ML19 is powered by 100 to 240 VAC, 1.5/0.75 A, 60/50 Hz.

Connect the AC power cable to the power input port on the rear of the monitor. Connect the other end into a nearby outlet.

Install Touch Screen Driver

Applies to touch screen monitors only. Instructions below apply to Windows systems. Both Serial and USB ports are present on all touch screen monitors, but only one should be used to connect the touch screen interface to the monitor.

All touch screen monitors are shipped with a CD-ROM that contains documentation and drivers for all major operating systems. To be sure that you have the most current information, please check the following Internet address:

http://www.HopelIndustrial.com/Touchscreen_Drivers.htm



IMPORTANT!

If you will be using a Serial connection, *connect the Serial cable first*, and then install the touch screen driver. If you will be using a USB connection, *install the touch screen driver first*, and then connect the USB cable.

Serial (RS-232) Connection

1. Connect one end of the Serial cable to the Serial input port on the rear of the monitor. Connect the other end to the Serial port on the host computer. Tighten the captive screws on the cable connectors to ensure adequate strain relief.

2. Select the appropriate driver for your operating system.
 - a. If downloading from the web address listed above, select the appropriate driver for your operating system.
 - b. If using the included CD, insert it into the host computer's CD-ROM drive. If the CD does not automatically run, browse the contents of the CD and open the **READ.ME.FIRST.htm** file in a web browser. Select the appropriate driver.

NOTE: For Windows 7 and Vista operating systems, you must save the driver to a location on your hard drive, then run using elevated privileges by right-clicking on the file and selecting "Run as administrator".

3. Click to "Run" the software when prompted. Follow on-screen instructions to download and execute the touch screen driver installation.

USB Connection

1. Select the appropriate driver for your operating system.
 - a. If downloading from the web address listed above, select the appropriate driver for your operating system.
 - b. If using the included CD, insert it into the host computer's CD-ROM drive. If the CD does not automatically run, browse the contents of the CD and open the **READ.ME.FIRST.htm** file in a web browser. Select the appropriate driver.

NOTE: For Windows 7 and Vista operating systems, you must save the driver to a location on your hard drive, then run using elevated privileges by right-clicking on the file and selecting "Run as administrator".

2. Click to "Run" the software when prompted. Follow on-screen instructions to download and execute the touch screen driver installation.
3. A cable retention bracket comes installed on the USB port on the rear of the monitor and will help to secure the cable and ensure adequate strain relief. Route one end of the USB cable through the retention bracket and connect it to the USB input port on the monitor. Connect the other end to the USB port on the host computer.

Calibrate the Touch Screen

Once the driver has finished installing, you are ready to calibrate the touch screen. Open the touch screen's Control Panel by clicking on the "Elo Touchscreen" icon, located in the host computer's Control Panel. Under the "General" tab, click the "Align" button to start the calibration routine.



Step 3: Install into Panel

Once you have completed the full bench-test configuration and confirmed that all components are working properly, you are ready to install the monitor into its panel cutout.



WARNING!

Hope Industrial Systems will not assume liability for damage to internal electronics due to improper installation. Contact Hope Industrial Systems if you need additional assistance.

1. Refer to the drawing below for the cutout dimensions for the HIS-ML19.

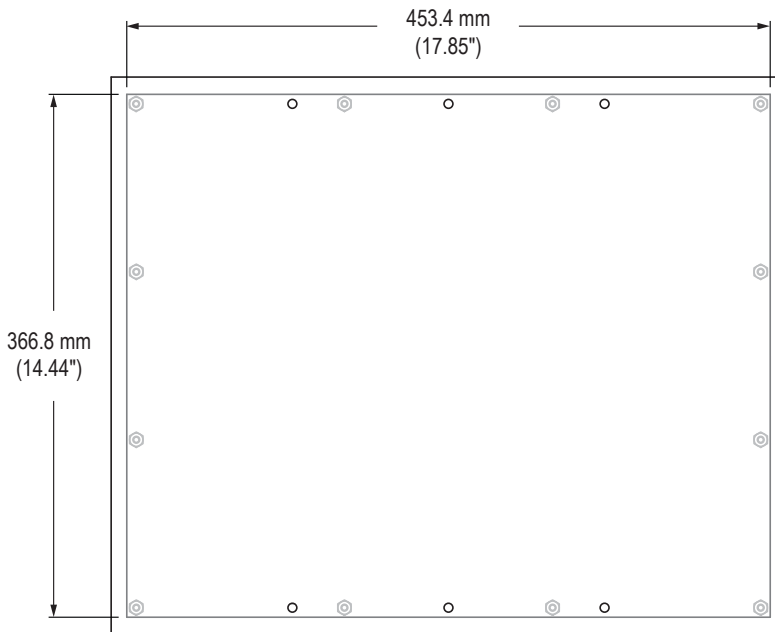

2. Locate position in panel for mounting of the monitor. Ensure that there is adequate space behind the panel. Allow extra space – 25.4 mm (1.0") behind and on each side – for air ventilation.

- Cut a rectangular hole in the panel.

► **Cutout Dimensions (W x H) for the HIS-ML19:**

453.4 mm x 366.8 mm (17.85" x 14.44"); ± 0.5 mm (0.020")

- Clean and deburr the panel hole.
- Separate the rear collar from the monitor by removing the 12 nuts.
- Refer to the enclosure mounting diagram below.

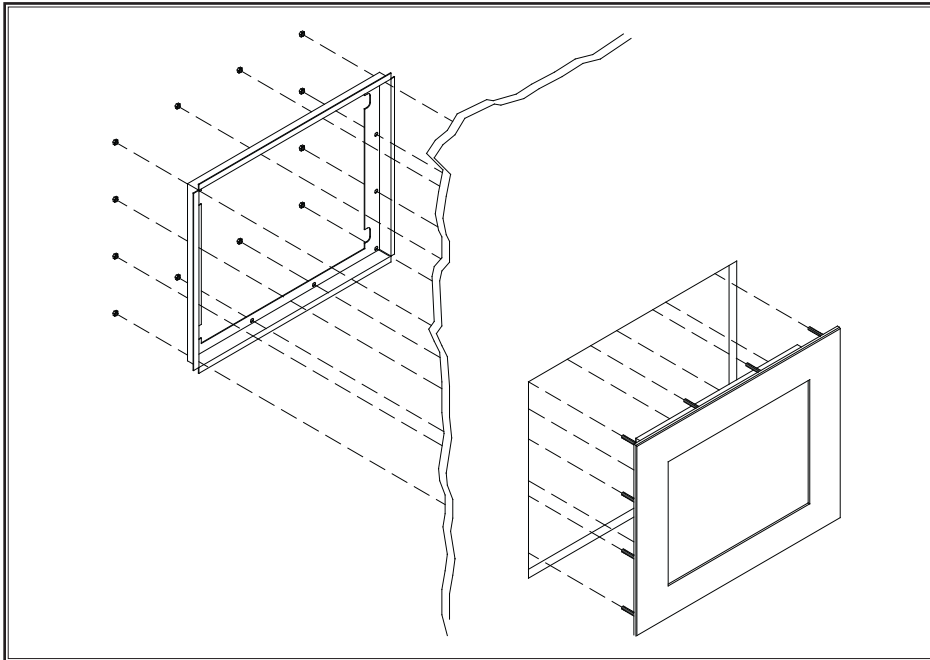

- Insert the unit into the front of the panel and re-attach the collar.

NOTE: Contact Hope Industrial Systems if for any reason your application does not allow for installation of the collar.

- Tighten all 12 nuts to a torque of 10-15 inch-pounds to ensure a watertight seal between the bezel gasket on the monitor and the equipment panel. Go around all nuts twice to ensure an even compression on gasket.

NOTE: If a torque wrench is not available, tighten all nuts evenly until bezel sits 1.6 to 2.4 mm (1/16" to 3/32") off the front of the panel.

Video Settings

Setting the Timing Mode

Setting the timing mode of your computer graphics adapter (or other video source) is important for maximizing the quality of the screen image and for minimizing eye strain. The timing mode consists of the resolution (e.g. 1280 x 1024) and refresh rate (or vertical frequency; e.g. 60 Hz). After setting the timing mode, use the On-Screen Display (OSD) controls to adjust the screen image.



TIP!

For the best picture quality, set your computer graphics adapter timing mode to:

VESA 1280 x 1024 @ 60 Hz

Please refer to the computer graphics adapter manufacturer's manual for instructions on setting the resolution and timing mode. In Microsoft Windows, these settings may be found at the following location:

- ▶ **ME, 2000, XP:** Control Panel > Display > Settings
 - ▶ **Vista:** Control Panel > Personalization > Display Settings
 - ▶ **Windows 7:** Control Panel > Appearance and Personalization > Adjust Screen Resolution
-



WARNING!



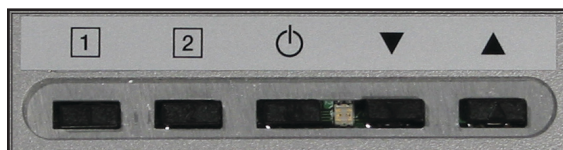
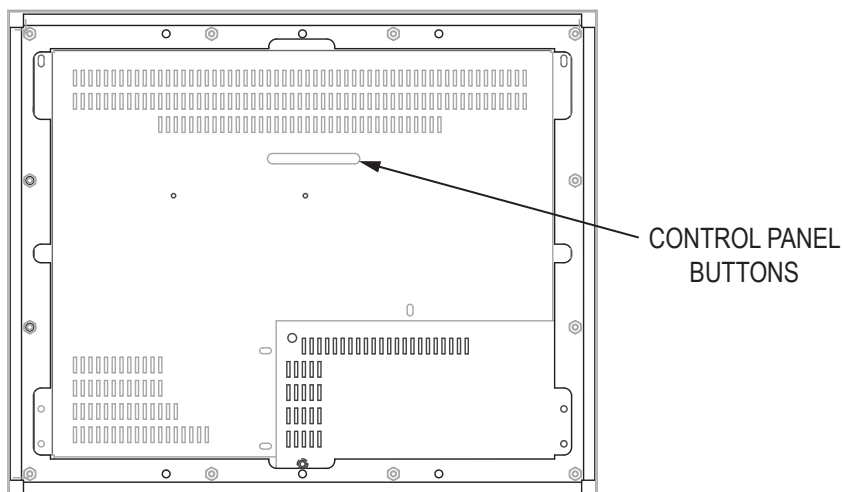

Do not set the graphics card in your computer to exceed the maximum refresh rate of 75 Hz; doing so may result in permanent damage to your display.

Control Panel Buttons

Use the control panel buttons located on the back of the monitor to display and adjust various settings on the On-Screen Display (OSD) menu.



1. To display the Main Menu, press button [1].
NOTE: All OSD menus and adjustments screens disappear automatically after 15 seconds. This is adjustable through the OSD Time Out setting in the Setup menu.
2. To select a control to adjust, press the up [▲] or down [▼] button to scroll through the menu.
3. Press button [2] to open the menu for a selected control.
4. To adjust the control, press the up [▲] or down [▼] button.
5. To save the adjustments and return to the main OSD menu, press button [1] once. To exit the OSD menu, press button [1] twice.

Button	Control	Functions
	Menu	<ul style="list-style-type: none"> • Opens the OSD menu. • Exits the OSD menu and saves adjustments.
	Enter	<ul style="list-style-type: none"> • Displays the control screen for the highlighted control. • Toggles between two controls on some screens.
	Power	<ul style="list-style-type: none"> • Turns the monitor on and off. • The Power Indicator light glows blue during normal operation and orange when the monitor is in Power Saving mode.
	Down / Brightness Adjust	When the OSD menu IS NOT displayed:
		<ul style="list-style-type: none"> • Shortcut to Brightness Adjust.
	Up / Contrast Adjust	When the OSD menu IS NOT displayed:
		<ul style="list-style-type: none"> • Shortcut to Contrast Adjust.
		When the OSD menu IS displayed:
		<ul style="list-style-type: none"> • Scrolls down and adjusts items in the menu down.
		When the OSD menu IS displayed:
		<ul style="list-style-type: none"> • Scrolls up and adjusts items in the menu up.

OSD and Power Lock Settings

- ▶ **OSD Lock:** Press and hold [1] and the up [▲] button for 10 seconds. If any buttons are pressed the message *OSD Locked* will display for 3 seconds.
- ▶ **OSD Unlock:** Press and hold [1] and the up [▲] button again for 10 seconds.
- ▶ **Power Button Lock:** Press and hold [1] and the down [▼] button for 10 seconds. If the power button is pressed, the message *Power Button Locked* will display for 3 seconds. With or without this setting, after a power failure, your monitor's power will automatically turn ON when power is restored.
- ▶ **Power Button Unlock:** Press and hold [1] and the down [▼] button again for 10 seconds.

On-Screen Display (OSD) Menus

To open the OSD menu, press button [1] once. The following screen will appear:

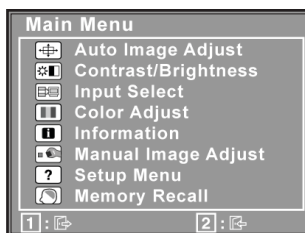

Main Menu	Description
Auto Image Adjust	Automatically sizes, centers, and fine tunes the video signal to eliminate waviness and distortion.
Contrast / Brightness	Includes the Contrast and Brightness functions.
Input Select	Allows the user to toggle between inputs.
Color Adjust	Provides several color adjustment modes.
Information	Displays the timing mode (video signal input).
Manual Image Adjust	Includes the H./V. Position, Horizontal Size, Fine Tune, Sharpness, Dynamic Contrast, and ECO Mode functions.
Setup Menu	Includes the Language Select, Resolution Notice, OSD Position, OSD Time Out, OSD Background, and Auto Power Off functions.
Memory Recall	Returns adjustments back to factory settings.

Auto Image Adjust Menu

The Auto Image Adjust menu automatically sizes, centers, and fine tunes the video signal to eliminate waviness and distortion.

NOTE: Auto Image Adjust works with most common video cards. If this function does not work on your display, lower the video refresh rate to 60 Hz and set the resolution to its pre-set value.

Contrast / Brightness Menu



The Contrast/Brightness menu includes the Contrast and Brightness functions.

Contrast / Brightness Menu	Description
Contrast	<ul style="list-style-type: none"> Adjusts the difference between the image background (black level) and the foreground (white level). This feature may also be accessed by pressing the up [▲] button outside of the OSD menu.
Brightness	<ul style="list-style-type: none"> Adjusts the background black level of the screen image. This feature may also be accessed by pressing the down [▼] button outside of the OSD menu.

Input Select Menu



The Input Select menu allows the user to toggle between inputs if there is more than one computer connected to the display.

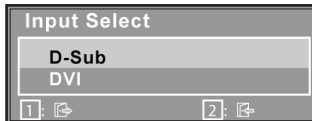

Color Adjust Menu



The Color Adjust menu provides several color adjustment modes, including preset color temperatures and a User Color mode which allows independent adjustment of red (R), green (G), and blue (B). The factory setting for this product is 6500K (6500 Kelvin).

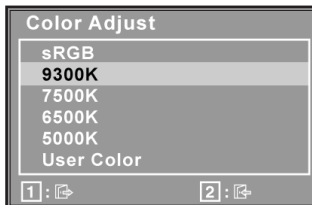

Color Adjust Menu	Description
sRGB	<p>This is quickly becoming the industry standard for color management, with support being included in many of the latest applications. Enabling this setting allows the LCD to more accurately display colors the way they were originally intended.</p> <p>NOTE: Enabling the sRGB setting will cause the Contrast and Brightness adjustments to be disabled.</p>
9300K	<p>Adds blue to the screen image for cooler white (used in most office settings with fluorescent lighting).</p>
7500K	<p>Adds blue to the screen image for cooler white (used in most office settings with fluorescent lighting).</p>
6500K	<p>Adds red to the screen image for warmer white and richer red.</p>
5000K	<p>Adds red to the screen image for a daylight color.</p>
User Color	<p>Individual adjustments for red (R), green (G), and blue (B).</p> <ol style="list-style-type: none"> 1. To select color (R, G, or B) press button [2]. 2. To adjust selected color, press the up [▲] or down [▼] button. <p>NOTE: If you select RECALL from the OSD Main Menu when the product is set to a Preset Timing Mode, colors return to the 6500K factory preset.</p>

Information Menu



The Information menu displays the timing mode (video signal input) coming from the graphics card in the computer. See your graphics card's user guide for instructions on changing the resolution and refresh rate (vertical frequency).

NOTE: VESA 1280 x 1024 @ 60 Hz (recommended) means that the resolution is 1280 x 1024 and the refresh rate is 60 Hz.

Manual Image Adjust Menu



The Manual Image Adjust menu includes the H./V. Position, Horizontal Size, Fine Tune, Sharpness, Dynamic Contrast, and ECO Mode functions.



Manual Image Adjust Menu	Description
H./V. Position (Horizontal / Vertical Position)	Moves the screen image left or right and up or down.
Horizontal Size	Adjusts the width of the screen image.
Fine Tune	Sharpens the focus by aligning text and/or graphics with pixel boundaries. NOTE: Try the Auto Image Adjust function first.
Sharpness	Adjusts the clarity and focus of the screen image.
Dynamic Contrast	Allows the user to turn the contrast ratio enhancement On or Off. Dynamic Contrast adjusts the brightness of the backlights to improve the contrast of the screen image (darker screen images will have better black levels).
ECO Mode	Provides lower power consumption by reducing the brightness. <ul style="list-style-type: none"> • Standard is the default brightness setting • Optimize reduces brightness by 25% • Conserve reduces brightness by 50%

Setup Menu



The Setup menu includes the Language Select, Resolution Notice, OSD Position, OSD Time Out, OSD Background, and Auto Power Off functions.

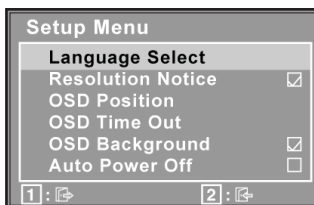

Setup Menu	Description
Language Select	Allows the user to choose the language used in the menus and control screens.
Resolution Notice	Advises the optimal resolution to use.
OSD Position	Allows the user to move the OSD menus and control screens.
OSD Time Out	Sets the length of time the OSD screen is displayed. For example, with a "15 second" time setting, if a control is not pushed within 15 seconds, the display screen disappears.
OSD Background	Allows the user to turn the OSD background On or Off.
Auto Power Off	When enabled, this setting will automatically power off the monitor when no signal is detected for 3 minutes.

Memory Recall Menu



The Memory Recall menu returns adjustments back to factory settings.

NOTE: This control does not affect changes made with the Language Select or Power Lock settings.

Cleaning Instructions



CAUTION!

DO NOT USE ABRASIVE MATERIALS, SUCH AS PAPER TOWELS OR DIRTY SHOP RAGS, ON THE DISPLAY AS IT WILL SCRATCH THE PROTECTIVE COATING. ALWAYS USE A SOFT CLOTH, PREFERABLY MADE OF COTTON.

All displays may be cleaned using any standard glass cleaner as long as there is no abrasive or oily content. Vinegar or ammonia will not hurt the screen.

The anti-reflective coatings on glass window-equipped displays are physically part of the surface of the glass and resist degradation to the Military Specifications.

To minimize over-run of cleaning solution, spray the cloth first and then clean the screen.

Troubleshooting

Video Troubleshooting



IMPORTANT!

If using a KVM extender, first try to resolve any problems using the solutions listed below. If the problem still exists, try bypassing the KVM extender. If this fixes the problem and allows the monitor to work properly, then the KVM extender is the source of the problem. Please refer to the troubleshooting section of the KVM extender manual or contact Hope Industrial Systems for additional assistance.

Symptom	Causes	Solutions
No image on the screen and control's Power Indicator light is not lit	Monitor is not powered on.	<ul style="list-style-type: none"> Press the Power button on the monitor and make sure the Power Indicator light is lit blue. Check power connections at the monitor and power source.
"No Signal" message box and no image on the screen	Video cable is not plugged in correctly.	Check the video cable connection at the monitor, PC, and/or KVM extender.
	PC is in Power Saving mode.	Power Saving mode can usually be exited by moving the mouse.
	PC is not powered on.	Ensure PC is powered on.
	PC is not sending signal.	Connect the PC to another known working monitor to check the PC source signal.
No image on the screen and control's Power Indicator light is lit orange	Video cable is not plugged in correctly.	Check the video cable connection at the monitor, PC, and/or KVM extender.
	PC is in Power Saving mode.	Power Saving mode can usually be exited by moving the mouse.
	PC is not powered on.	Ensure PC is powered on.
	PC is not sending signal.	Connect the PC to another known working monitor to check the PC source signal.



Symptom	Causes	Solutions
"Out of Range" message box and no image on the screen	The source signal exceeds the maximum resolution and/or refresh rate that the monitor can handle (> 1280 x 1024 resolution or > 75 Hz refresh rate).	Adjust the computer settings to the monitor's native resolution: 1280 x 1024 @ 60 Hz
Incorrectly displayed or partial image on the screen	Monitor has not been adjusted correctly for the source signal.	<ul style="list-style-type: none"> • Activate the "Auto Image Adjust" function in the OSD menu. • Fine tune the picture by manually adjusting the image. In the OSD menu, these functions can be found in the "Manual Image Adjust" menu.
Wrong or abnormal colors (white is not white)	Monitor color settings are incorrectly adjusted.	Reset the monitor to the factory default settings by activating the "Memory Recall" function in the OSD.
	Video cable is not securely connected.	If any colors (red, green, or blue) are missing, check the video cable to make sure it is securely connected.
	Video cable is bad.	Check to make sure there are no loose or broken pins in the cable connector. Shorts in the cable could also cause an improper image to display.
Screen image is dim	Brightness and/or contrast settings are not set properly.	Adjust the monitor's brightness and contrast settings in the OSD's "Contrast/Brightness" menu.
The message "OSD Locked" appears	The OSD has been locked to prevent unauthorized changes to display settings.	Press and hold [1] and the up [▲] button for 10 seconds.
The message "Power Button Locked" appears	The Power button has been locked to prevent unauthorized shut down of the monitor.	Press and hold [1] and the down [▼] button for 10 seconds.



Touch Screen Troubleshooting

Applies to touch screen monitors only. To be sure that you have the most current driver, please check the following Internet address:

http://www.HopeIndustrial.com/Touchscreen_Drivers.htm

Symptom	Causes	Solutions
No response when touching the touch screen	Touch screen driver has not been installed.	Download and install the latest driver from the Hope Industrial website.
	Touch screen cable is not plugged in correctly.	Make sure either the USB or Serial cable is securely connected to the monitor and PC. Do not connect both.
	If using a USB connection, does the USB cable length exceed 3 meters?	USB cables have a 3 meter limitation and could cause no touch response if this is exceeded.
	If using a Serial connection, is the Serial cable plugged into the correct COM port?	Ensure that the Serial cable is connected to the COM port being used prior to installing the touch screen driver.
The cursor moves but does not follow my finger when touching the touch screen	Touch screen driver has not been installed.	Download and install the latest driver from the Hope Industrial website.
	Touch screen has not been calibrated.	<p>Activate the calibration utility. In Windows systems, these settings may be found at the following location:</p> <p>Control Panel > Elo Touchscreen > "General" Tab</p> <ul style="list-style-type: none"> • Press the Align button. • Touch all targets as they appear to calibrate the touch screen. • Press the Green Check button when verified.

Specifications

Display	
Type	Thin-film transistor (TFT) Active Matrix Liquid Crystal
Size	19" diagonal
Image Size (W x H)	376 mm x 301 mm (14.8" x 11.9")
Native Resolution	SXGA (1280 x 1024, 5:4 aspect ratio)
Minimum Resolution	VGA (640 x 480)
Pixel Pitch	0.294 mm x 0.294 mm
Number of Colors	16.7 million
Brightness (white)	250 nits (cd/m ²)
Viewing Angle (Hori/Vert)	170° / 160°
Contrast Ratio (typical)	1000:1 (static); 100,000:1 (dynamic)
Backlight	Two CCFTs (Cold Cathode Fluorescent Tube); 50,000 hour brightness half-life

Electrical	
Monitor Input	100 to 240 VAC, 1.5/0.75 A, 60/50 Hz
Power Consumption	~ 25 W
Power Consumption (Standby mode)	< 1 W

Environmental	
Temperature	0° to 50°C (32° to 122°F)
Humidity	20% to 90% non-condensing
Operating Shock	15 g, 6 msec, half-sine
Operating Vibration (sine)	1.0g, swept sine 9 – 500 Hz
Transport Vibration (random)	0.1g ² / Hz, 10 – 200 Hz 0.03g ² / Hz, 200 – 2000 Hz
Altitude	<ul style="list-style-type: none"> Operating: up to 10,000 feet Non-operating: up to 40,000 feet

Video	
Input Connectors	<ul style="list-style-type: none"> • HD-15, DVI-D • Optional BNC input using HD-15 to 5-wire BNC adapter; see "Input Signal Formats" for a list of compatible video signals. • Optional DisplayPort input using DisplayPort to VGA or DisplayPort to DVI adapter.
Input Signal Formats	<ul style="list-style-type: none"> • RGB Analog video, 0.7/1.0 Vp-p, 75 Ohms Compatible sync modes: Separate H/V sync • DVI <p>NOTE: NTSC/PAL composite input available (call for details)</p>
Horizontal Scan	30 – 82 kHz
Vertical Scan	56 – 75 Hz
Supported Video Standards	<ul style="list-style-type: none"> • 1280 x 1024 @ 60, 75 Hz • 1280 x 960 @ 60, 75 Hz • 1024 x 768 @ 60, 70, 72, 75 Hz • 800 x 600 @ 56, 60, 72, 75 Hz • 720 x 400 @ 70 Hz • 640 x 480 @ 60, 75 Hz
Response Rate (typical)	5 ms

Functional	
Control Panel Buttons	1 (Menu), 2 (Enter), Power, Down, Up
On-Screen Display (OSD) Menus	Auto Image Adjust, Contrast / Brightness, Input Select, Color Adjust, Information, Manual Image Adjust, Setup, Memory Recall
Touch Screen Option	5-wire resistive system; emulates a mouse; Serial (RS-232) and USB interface to host computer

Physical	
Enclosure Type	Panel mount; rear collar compresses gasket against panel (5/16" maximum panel thickness); held by 12 M5 studs
Panel Rating (with proper installation)	Built to IP65/IP66 standards <ul style="list-style-type: none"> • NEMA/UL Type 12/4 (Black Powder-Coated Faceplate) • NEMA/UL Type 12/4/4X (Stainless Steel Faceplate)
Depth	<ul style="list-style-type: none"> • Total Product Depth – 61.6 mm (2.43") • Depth Behind Front Edge of Panel – 54.5 mm (2.15") <p>NOTE: Design to maximum depth of 69.0 mm (62.0 mm behind front edge of panel) to ensure future compatibility with later revisions and replacement units.</p>
Front Bezel Outside Dimensions (W x H x D)	482.6 mm x 398.8 mm x 7.1 mm (19.0" x 15.7" x 0.28") (not including gasket)
Cutout Dimensions (W x H)	453.4 mm x 366.8 mm (17.85" x 14.44"); ± 0.5 mm (0.020")
Net Weight	18 lbs.
Shipping Weight	22 lbs.

Compliances and Certifications	
Electrical	<ul style="list-style-type: none"> • UL 60950 3rd Edition / cUL Recognized Component (File No. E212889) • UL 508A Listed (File No. E318630) • FCC Class A • CE
Environmental	<ul style="list-style-type: none"> • RoHS (Hazardous Substances) • IEC 60721-3 (Reliability) • WEEE (Registration No. WEE/DJ1859ZX for UK only)
Enclosure	UL 50E (File No. E318630)
Hazardous Location	For monitors with model numbers HIS-ML19- __ HF only: UL Rated for Hazardous Locations: Industrial Control Equipment for Hazardous Location: Listed for Class I, Division 2 for Groups A, B, C, D; Recognized for Class II, III, Division 2 for Groups F, G; Temp Code T6 (File No. E328481) per ANSI/ISA 12.12.01-2007

Warranty Statement

Who is Covered?

This warranty covers the purchaser of this product only and is not transferable without our written consent.

What Does This Warranty Cover and What is the Period of Coverage?

We warrant this product to be free from defects in material and workmanship, subject to the conditions set forth below. The warranty on all industrial display products, KB-R2 and KB-M2 keyboard series, KVM2 extender series, and ENCL-TC01, ENCL-TC02, and ENCL-PC10 enclosure series remains in force for a three year period beginning on the date we invoice you. The warranty period on KB-PL1 keyboards is two years, and all other keyboards carry a one year warranty. If Hope Industrial Systems repairs or replaces a product under warranty, its warranty term is not extended.

What Will We Do to Correct Problems and How Do You Get Service?

We will repair or replace (at our sole option) any part of the unit which proves to be defective. Replacement parts may be new or refurbished and will meet the same specifications of the original parts or unit. For orders sold through our U.S. operations, we will return the product to you by the shipping method we choose in the U.S.A. at our expense. You must pay for shipments to locations outside of the U.S.A. For products originally sold through Hope Industrial U.K., return shipping to and from Hope Industrial repair facilities and any EU member country (except Malta and Cyprus) will be provided using a pre-paid UPS shipping label sent via email. In order to receive warranty service you must get prior approval from Hope Industrial Systems. To request warranty service you can telephone us at +1 678 762 9790 or +44 (0) 20 7193 2618 in the United Kingdom or send an email to support@HopeIndustrial.com. If we determine that warranty service is needed we will give you a Return Material Authorization (RMA) number. This RMA number must be conspicuously marked on the outside of the shipping box. Hope Industrial Systems will not accept shipments not accompanied by the RMA number. Except where otherwise noted, you must ship or deliver the product to Hope Industrial Systems Freight prepaid.

What Does This Warranty Not Cover?

This warranty does not cover equipment which has been damaged due to misuse, abuse, or accident such as: operating the equipment outside of published specifications; exposure to chemicals or gases not covered by specified NEMA standards; displaying fixed images for long periods of time resulting in afterimage effects; improper or unauthorized repair by anyone other than Hope Industrial Systems or a service agency authorized by Hope Industrial Systems to perform such repairs; fire, flood, "acts of God", or other contingencies beyond the control of Hope Industrial Systems.

Hope Industrial Systems' responsibility for malfunctions and defects in hardware is limited to repair and replacement as set forth in this warranty statement. Hope Industrial Systems shall not be liable for direct, indirect, incidental, consequential, or other types of damages resulting from the use of any Hope Industrial Systems product other than the liability stated above. These warranties are in lieu of all other warranties express or implied, including, but not limited to, the implied warranties of merchantability or fitness for a particular purpose. Some states do not allow the exclusion of implied warranties or the limitation or exclusion of liability for incidental or consequential damages so the above exclusions or limitations may not apply to you. You are cautioned that the performance of this product can be affected by many factors, such as system configuration, software, application, and operator control of the system. It is your responsibility to determine suitability of this product for your purpose and application.

Hope Industrial Systems, Inc.

US / International

1325 Northmeadow Parkway
Suite 100
Roswell, GA 30076
United States

Toll Free: (877) 762-9790
International: +1 (678) 762-9790
Fax: +1 (678) 762-9789

Sales and Customer Service: sales@HopeIndustrial.com
Support and Returns: support@HopeIndustrial.com
Accounting Department: accounting@HopeIndustrial.com
www.HopeIndustrial.com

UK

Harling Road
Snetterton
Norwich
NR16 2JU
United Kingdom

Phone: +44 (0) 20 7193 2618
Fax: +44 (0) 20 7117 1194

Sales and Customer Service: sales@HopeIndustrial.co.uk
Support and Returns: support@HopeIndustrial.co.uk
Accounting Department: accounting@HopeIndustrial.co.uk
www.HopeIndustrial.co.uk

