

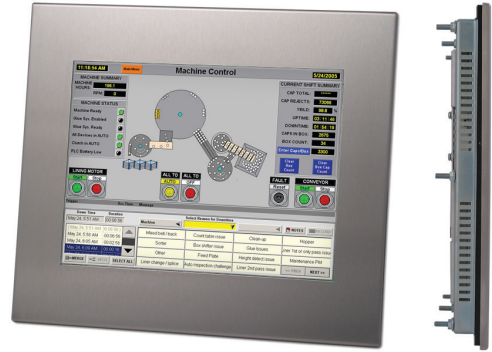

HOPE INDUSTRIAL SYSTEMS



12" PANEL MOUNT INDUSTRIAL MONITOR

REVISION D

USER MANUAL

Model No. HIS-ML12- __ _ D



Table of Contents

Safety and Regulatory Information	3
FCC Notice	3
Waste Electrical and Electronic Equipment Directive (WEEE)	3
Mechanical Drawings	4
Front and Side Views	4
Bottom View	4
Installation Instructions	5
Step 1: Prepare for Installation	5
Step 2: Bench-test Configuration	6
Install Cable Connections	6
Install Touch Screen Driver	7
Step 3: Install into Panel	9
Video Settings	11
Setting the Timing Mode	11
Control Panel Buttons	12
On-Screen Display (OSD) Menus.....	14
Cleaning Instructions	16
Troubleshooting	17
Video Troubleshooting	17
Touch Screen Troubleshooting	19
Specifications	20
Display	20
Video.....	20
Electrical	21
Environmental	21
Functional	21
Physical	22
Compliances and Certifications	22
Warranty Statement	23



Safety and Regulatory Information



WARNING!

To prevent fire or shock hazard, do not expose live components to rain or moisture. Dangerously high voltages are present inside the unit. Do not disassemble the unit. Refer servicing to qualified personnel only.

This equipment is not intended for use in critical applications where its failure to operate would create immediate life threatening circumstances. Applications including, but not limited to, nuclear reactor control, aerospace navigation systems and life support systems are not appropriate for this product.

This product is intended to be mounted in a suitable cabinet or other enclosure. The NEMA 4, 4X, or 12 ratings are applicable only when properly installed in a like rated enclosure.

FCC Notice

This equipment has been tested and found to comply with the limits for a Class A digital device, pursuant to Part 15 of the FCC Rules. These limits are designed to provide reasonable protection against harmful interference when the equipment is operated in a commercial environment. This equipment generates, uses, and can radiate radio frequency energy and, if not installed and used in accordance with the instruction manual, may cause harmful interference to radio communications. Operation of this equipment in a residential area is likely to cause harmful interference in which case the user will be required to correct the interference at his own expense. Any changes or modifications not expressly approved by the grantee of this device could void the user's authority to operate the device.

Waste Electrical and Electronic Equipment Directive (WEEE)

The following information is only for EU-member states:

The mark shown to the right is in compliance with the Waste Electrical and Electronic Equipment Directive 2002/96/EC (WEEE).



The mark indicates the requirement NOT to dispose of the equipment as unsorted municipal waste, but use the return and collection systems according to local law. Users should contact their supplier and check the terms and conditions of the purchase contract. When purchased directly from Hope Industrial Systems, you may contact technical support for disposal arrangements.

Mechanical Drawings

Front and Side Views

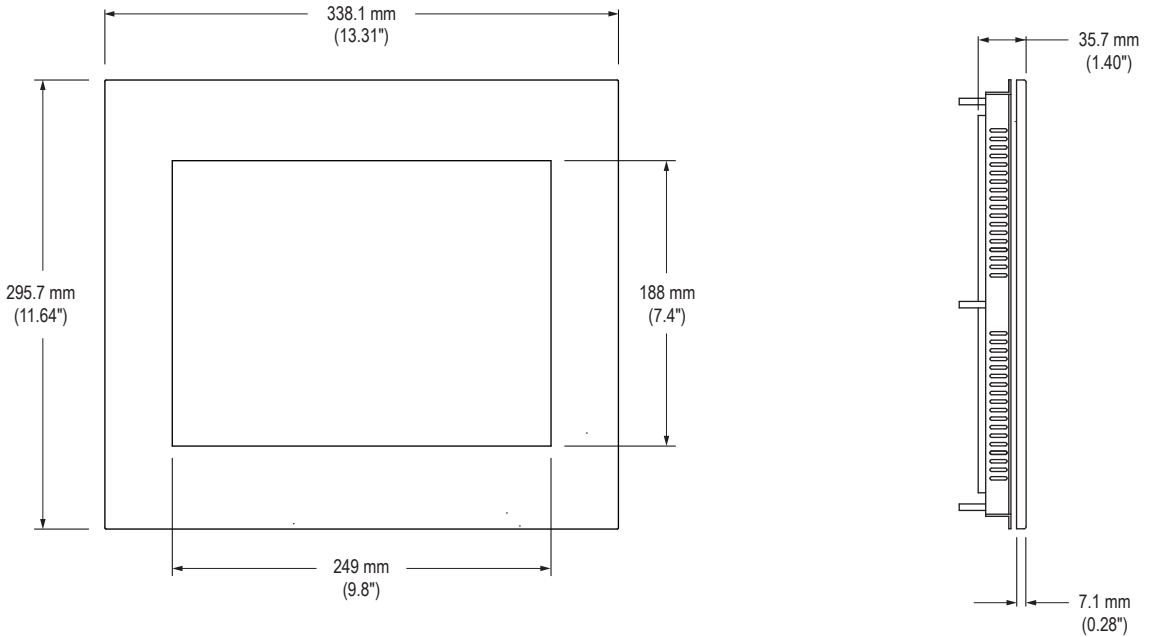

Bottom View

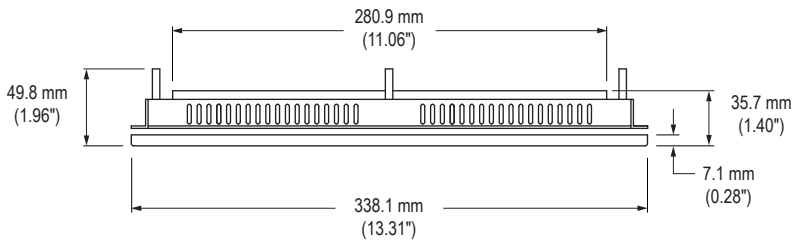

Installation Instructions

Step 1: Prepare for Installation



IMPORTANT!

Perform the following steps **BEFORE** installation of the monitor into the panel.

1. Ensure that sufficient power is available.
2. Ensure that sufficient space is available to allow for proper air flow into and out of the unit.
3. Ensure that the air temperature around the unit (top and bottom) *will not exceed the rated specifications of the unit.*



- ▶ **The maximum rated temperature for the HIS-ML12 is 50°C (122°F).**
 - ▶ **Remember that heat rises – the temperature at the top of the cabinet will be much hotter than at the bottom if air inside the enclosure is not actively circulating. Even in a sealed enclosure, use of a circulation fan can greatly reduce temperature.**
 - ▶ **Also, remember that even though this product is designed to operate at 50°C, the life span of any electronic device is shortened when it is consistently operated at high temperatures. Therefore, it is wise to take steps to keep the temperature of the ambient air around the unit as low as possible.**
4. Ensure that the ambient humidity of the air around the unit *does not exceed the specifications of the unit.*
 - ▶ **The maximum rated humidity for the HIS-ML12 is 90% non-condensing.**

Step 2: Bench-test Configuration

Make sure everything works before installing into the production environment.



TIP!

If using a KVM extender, please refer to the installation instructions included with the KVM extender module. It is particularly important to bench-test the full configuration prior to final installation. This will help to identify and troubleshoot any system issues while configuration changes may still be easily made.

Install Cable Connections

All monitors are shipped with a 6 ft. (1.8 m) VGA video cable, 6 ft. (1.8 m) power cable, and power supply, unless longer cables were ordered in their place. If you ordered a touch screen monitor, you also received a 6 ft. (1.8 m) USB cable, unless a longer cable was ordered in its place. Serial (RS-232) cables may be ordered separately.

The cable ports are located on the rear of the monitor. Refer to the following diagram and instructions to connect power, video, and touch screen (if applicable) to your monitor.

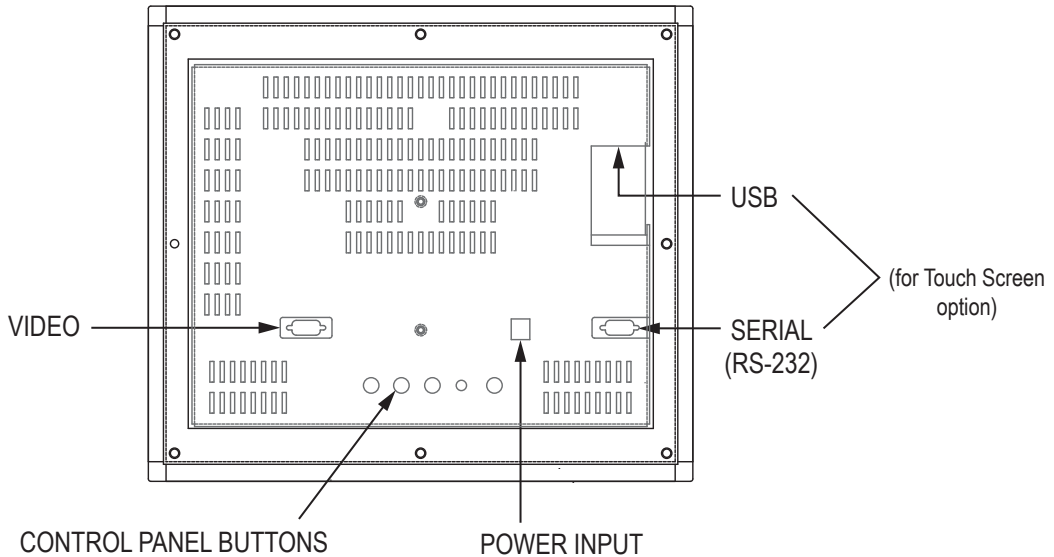

Video Connection

The HIS-ML12 supports analog video. Connect one end of the VGA video cable to the HD-15 input port on the rear of the monitor. Connect the other end to the video output port on the host computer.

Power Connection

The HIS-ML12 is powered by 12 VDC, 2.5 A (100 to 240 VAC, 60/50 Hz with external power adapter).

Connect the external power adapter barrel connector to the DC power input on the rear of the monitor. Connect the supplied AC power cable to the external power adapter and to a nearby outlet. Secure the external power adapter to the rear of the monitor using the supplied bracket.

Install Touch Screen Driver

Applies to touch screen monitors only. Instructions below apply to Windows systems. Both Serial and USB ports are present on all touch screen monitors, but only one should be used to connect the touch screen interface to the monitor.

All touch screen monitors are shipped with a CD-ROM that contains documentation and drivers for all major operating systems. To be sure that you have the most current information, please check the following Internet address:

http://www.HopelIndustrial.com/Touchscreen_Drivers.htm



IMPORTANT!

If you will be using a USB connection, *install the touch screen driver first*, and then connect the USB cable. If you will be using a Serial connection, *connect the Serial cable first*, and then install the touch screen driver.

USB Connection

1. Select the appropriate driver for your operating system.
 - a. If downloading from the web address listed above, select the appropriate driver for your operating system.
 - b. If using the included CD, insert it into the host computer's CD-ROM drive.

If the CD does not automatically run, browse the contents of the CD and open the **READ.ME.FIRST.htm** file in a web browser. Select the appropriate driver.

2. Click to "Run" the software when prompted. Follow on-screen instructions to download and execute the touch screen driver installation.
3. A cable retention clip comes installed on the USB port on the rear of the monitor and will help to secure the cable and ensure adequate strain relief. Without removing the clip, route one end of the USB cable through the retention clip and connect it to the USB input port on the monitor. Connect the other end to the USB port on the host computer.

Serial (RS-232) Connection

1. Connect one end of the Serial cable to the Serial input port on the rear of the monitor. Connect the other end to the Serial port on the host computer. Tighten the captive screws on the cable connectors to ensure adequate strain relief.
2. Select the appropriate driver for your operating system.
 - a. If downloading from the web address listed above, select the appropriate driver for your operating system.
 - b. If using the included CD, insert it into the host computer's CD-ROM drive. If the CD does not automatically run, browse the contents of the CD and open the **READ.ME.FIRST.htm** file in a web browser. Select the appropriate driver.
3. Click to "Run" the software when prompted. Follow on-screen instructions to download and execute the touch screen driver installation.

Calibrate the Touch Screen

Once the driver has finished installing, you are ready to calibrate the touch screen. Open the touch screen's Control Panel by clicking on the "Elo Touchscreen" icon, located in the host computer's Control Panel. Under the "General" tab, click the "Align" button to start the calibration routine.



Step 3: Install into Panel

Once you have completed the full bench-test configuration and confirmed that all components are working properly, you are ready to install the monitor into its panel cutout.



WARNING!

Hope Industrial Systems will not assume liability for damage to internal electronics due to improper installation. Contact Hope Industrial Systems if you need additional assistance.

1. Refer to the drawing below for the cutout dimensions for the HIS-ML12.

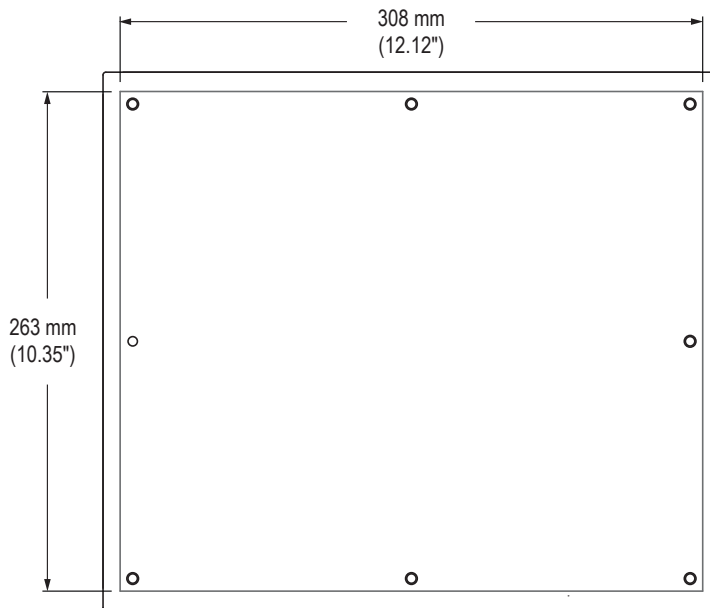

2. Locate position in panel for mounting of the monitor. Ensure that there is adequate space behind the panel. Allow extra space – 12.7 mm (0.5") behind and on each side – for air ventilation.

3. Cut a rectangular hole in the panel.

► **Cutout Dimensions (W x H) for the HIS-ML12:**

308 mm x 263 mm (12.12" x 10.35"); ± 0.5 mm (0.020")

4. Clean and deburr the panel hole.

5. Separate the rear collar from the monitor by removing the 8 nuts.

6. Refer to the enclosure mounting diagram below.

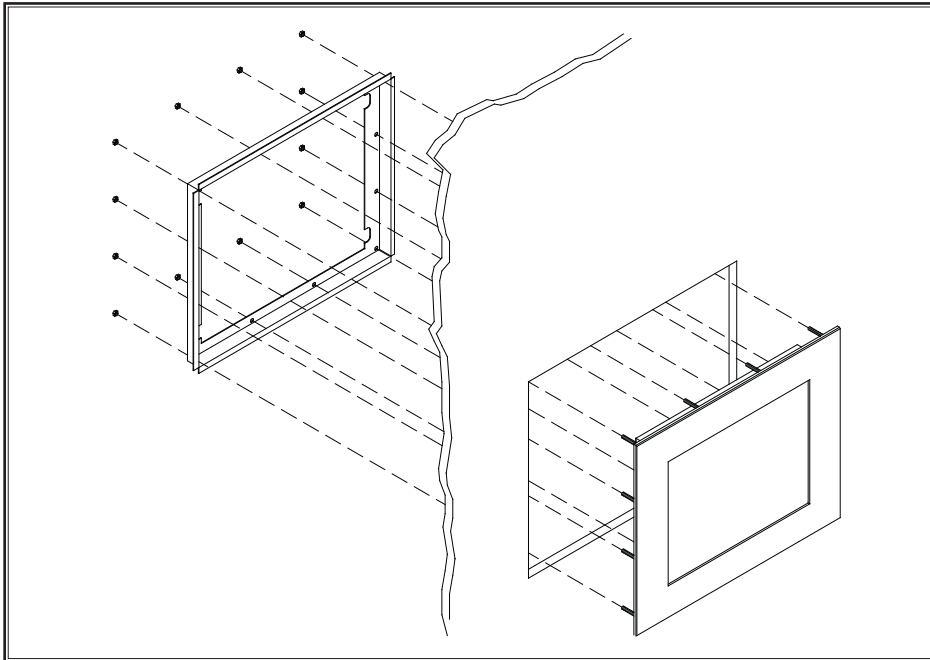

7. Insert the unit into the front of the panel and re-attach the collar.

NOTE: Contact Hope Industrial Systems if for any reason your application does not allow for installation of the collar.

8. Tighten all 8 nuts to a torque of 10-15 inch-pounds to ensure a watertight seal between the bezel gasket on the monitor and the equipment panel. Go around all nuts twice to ensure an even compression on gasket.

NOTE: If a torque wrench is not available, tighten all nuts evenly until bezel sits 1.6 to 2.4 mm (1/16" to 3/32") off the front of the panel.

Video Settings

Setting the Timing Mode

Setting the timing mode of your computer graphics adapter (or other video source) is important for maximizing the quality of the screen image and for minimizing eye strain. The timing mode consists of the resolution (e.g. 800 x 600) and refresh rate (or vertical frequency; e.g. 60 Hz). After setting the timing mode, use the On-Screen Display (OSD) controls to adjust the screen image.



TIP!

For the best picture quality, set your computer graphics adapter timing mode to:

VESA 800 x 600 @ 60 Hz

Please refer to the computer graphics adapter manufacturer's manual for instructions on setting the resolution and timing mode. In Microsoft Windows, these settings may be found at the following location:

- ▶ **2000, XP:** Control Panel > Display > Settings
- ▶ **Vista:** Control Panel > Personalization > Display Settings
- ▶ **Windows 7, 8:** Control Panel > Appearance and Personalization > Adjust Screen Resolution





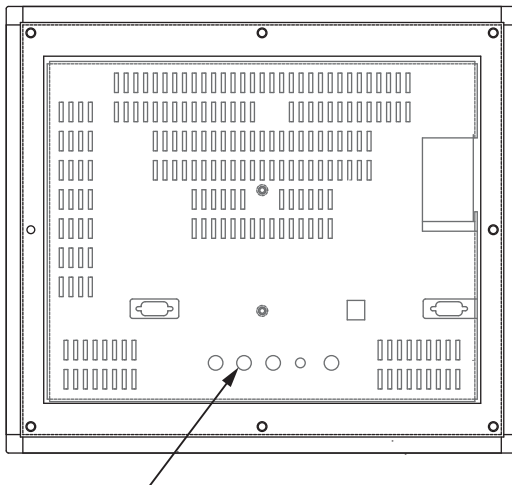

Control Panel Buttons

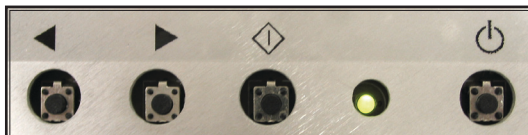



Use the control panel buttons located on the back of the monitor to display and adjust various settings on the On-Screen Display (OSD) menu.



CONTROL PANEL BUTTONS



1. To display the Main Menu, press the  button.
NOTE: All OSD menus and adjustments screens disappear automatically after 10 seconds.
2. To select a control to adjust, press the left [] or right [] button to scroll through the menu.
3. Press the  button to open the menu for a selected control.
4. To adjust the control, press the left [] or right [] button.

Button	Control	Functions
	Left / Down	When the OSD menu IS displayed: <ul style="list-style-type: none"> • Scrolls left and adjusts items in the menu down.
	Right / Up	When the OSD menu IS displayed: <ul style="list-style-type: none"> • Scrolls right and adjusts items in the menu up.
	Menu	When the OSD menu IS NOT displayed: <ul style="list-style-type: none"> • Opens the OSD menu.
		When the OSD menu IS displayed: <ul style="list-style-type: none"> • Selects the highlighted menu function.
	Power Indicator Light	<ul style="list-style-type: none"> • LED lit green – power is ON • LED not lit – power is OFF • LED lit orange – monitor is in Power Saving mode
	Power	Turns the monitor on and off.

NOTE: This unit has "Energy Star" capability – you may leave the monitor power On when the computer is powered Off.

On-Screen Display (OSD) Menus

To open the OSD menu, press the  button.

Menu	Description
Brightness	Adjusts the Brightness. 101 scales of brightness are available (0 to 100).
Contrast	Adjusts the Contrast. 101 scales of contrast are available (0 to 100).
H. Position (Horizontal Position)	Moves the screen image left or right.
V. Position (Vertical Position)	Moves the screen image up or down.
Phase	Adjusts the focus and clarity of the display. 101 scales are available (0 to 100).
Clock	Provides a frequency-tracking feature that allows the user to achieve stability and clarity.
Auto Adjustment	Adjusts the size of the display to fill the screen.
OSD H. Position	Moves the position of the OSD menu left or right.
OSD V. Position	Moves the position of the OSD menu up or down.
Graphics Text	<p>Allows the operator to choose a display that maximizes graphics text quality. Graphics Text works in the following resolutions:</p> <ul style="list-style-type: none"> • 640 x 400 @ 70 Hz • 720 x 400 @ 70 Hz <p>Refer to the Specifications section of this manual for a full list of supported video standards.</p>
Recall	Returns adjustments back to factory default settings.

Menu	Description
Language	Allows the user to choose the language used in the OSD menu. Five language options are available: English, German, French, Spanish, and Italian.
Color Temperature	Three different modes are available: <ul style="list-style-type: none">• User – allows the user to make individual adjustments for Red (User R), Green (User G), and Blue (User B)• 6500 – CIE coordinated Color Temperature of 6500°K• 9300 – CIE coordinated Color Temperature of 9300°K
Exit	Saves the settings and exits the OSD menu.

Cleaning Instructions



CAUTION!

DO NOT USE ABRASIVE MATERIALS, SUCH AS PAPER TOWELS OR DIRTY SHOP RAGS, ON THE DISPLAY AS IT WILL SCRATCH THE PROTECTIVE COATING. ALWAYS USE A SOFT CLOTH, PREFERABLY MADE OF COTTON.

All displays may be cleaned using any standard glass cleaner as long as there is no abrasive or oily content. Vinegar or ammonia will not hurt the screen.

The anti-reflective coatings on glass window-equipped displays are physically part of the surface of the glass and resist degradation to the Military Specifications.

To minimize over-run of cleaning solution, spray the cloth first and then clean the screen.

Troubleshooting

Video Troubleshooting



IMPORTANT!

If using a KVM extender, first try to resolve any problems using the solutions listed below. If the problem still exists, try bypassing the KVM extender. If this fixes the problem and allows the monitor to work properly, then the KVM extender is the source of the problem. Please refer to the troubleshooting section of the KVM extender manual or contact Hope Industrial Systems for additional assistance.

Symptom	Causes	Solutions
No image on the screen and control's Power Indicator light is not lit	Monitor is not powered on.	<ul style="list-style-type: none"> Press the Power button on the monitor and make sure the Power Indicator light is lit green. Check power connections at the monitor and power source. Ensure the power supply is receiving power by checking for the green LED.
"No Input Signal" message box and no image on the screen	Video cable is not plugged in correctly.	Check the video cable connection at the monitor, PC, and/or KVM extender.
	PC is in Power Saving mode.	Power Saving mode can usually be exited by moving the mouse or pressing a key on the keyboard.
	PC is not powered on.	Ensure PC is powered on.
	PC is not sending signal.	Connect the PC to another known working monitor to check the PC source signal.

Symptom	Causes	Solutions
No image on the screen and control's Power Indicator light is lit orange	Video cable is not plugged in correctly.	Check the video cable connection at the monitor, PC, and/or KVM extender.
	PC is in Power Saving mode.	Power Saving mode can usually be exited by moving the mouse or pressing a key on the keyboard.
	PC is not powered on.	Ensure PC is powered on.
	PC is not sending signal.	Connect the PC to another known working monitor to check the PC source signal.
"Out of Range" message box and no image on the screen	The signal from the computer exceeds the maximum resolution and/or refresh rate that the monitor can handle (> 800 x 600 resolution or > 60 Hz refresh rate).	Adjust the computer settings to the monitor's native resolution: 800 x 600 @ 60 Hz
Incorrectly displayed or partial image on the screen	Monitor has not been adjusted correctly for the source signal.	<ul style="list-style-type: none"> • Activate the "Auto Adjustment" function in the OSD menu. • Manually adjust the image using the "V-Position" and "H-Position" functions in the OSD menu.
Wrong or abnormal colors (white is not white)	Monitor color settings are incorrectly adjusted.	Reset the monitor to the factory default settings by activating the "Recall" function in the OSD menu.
	Video cable is bad.	Check to make sure there are no loose or broken pins in the cable connector. Switch to a known good video cable.
Screen image is dim	Brightness and/or contrast settings are not set properly.	Adjust the monitor's brightness and contrast settings in the OSD menu.

Touch Screen Troubleshooting

Applies to touch screen monitors only. To be sure that you have the most current driver, please check the following Internet address:

http://www.HopeIndustrial.com/Touchscreen_Drivers.htm

Symptom	Causes	Solutions
No response when touching the touch screen	Touch screen driver has not been installed.	Download and install the latest driver from the Hope Industrial website.
	Touch screen cable is not plugged in correctly.	Make sure either the USB or Serial cable is securely connected to the monitor and PC. Do not connect both.
	If using a USB connection, does the USB cable length exceed 3 meters?	USB cables have a 3 meter limitation and could cause no touch response if this is exceeded.
	If using a Serial connection, is the Serial cable plugged into the correct COM port?	Ensure that the Serial cable is connected to the COM port being used prior to installing the touch screen driver.
The cursor moves but does not follow my finger when touching the touch screen	Touch screen driver has not been installed.	Download and install the latest driver from the Hope Industrial website.
	Touch screen has not been calibrated.	<p>Activate the calibration utility. In Windows systems, these settings may be found at the following location: Control Panel > Elo Touchscreen > "General" Tab</p> <ul style="list-style-type: none"> • Press the Align button. • Touch all targets as they appear to calibrate the touch screen. • Press the Green Check button when verified.

Specifications

Display	
Type	Thin-film transistor (TFT) Active Matrix Liquid Crystal
Size	12.1" diagonal
Image Size (W x H)	246 mm x 184.5 mm (9.7" x 7.3")
Native Resolution	SVGA (800 x 600, 4:3 aspect ratio)
Minimum Resolution	VGA (640 x 350)
Pixel Pitch	0.308 mm x 0.308 mm
Number of Colors	262,144
Brightness (white)	400 nits (cd/m ²)
Viewing Angle (Hori/Vert)	160° / +60°, -50°
Contrast Ratio (typical)	600:1
Backlight	Two CCFTs (Cold Cathode Fluorescent Tube); 50,000 hour brightness half-life

Video	
Input Connectors	<ul style="list-style-type: none"> • HD-15 • Optional BNC input using HD-15 to 5-wire BNC adapter; see "Input Signal Formats" for a list of compatible video signals. • Optional DisplayPort input using DisplayPort to VGA adapter.
Input Signal Formats	RGB Analog video, 0.7 Vp-p, 75 Ohms Compatible sync modes: Separate H/V sync, Combined sync NOTE: NTSC/PAL composite input available (call for details)
Horizontal Scan	31 – 38 kHz
Vertical Scan	60 – 75 Hz
Supported Video Standards	<ul style="list-style-type: none"> • Standard VGA – 640 x 480 @ 60 Hz • SVGA – 800 x 600 @ 60 Hz
Response Rate (typical)	35 ms

Electrical	
Power Adapter Input	100 to 240 VAC, 1.2 A, 60/50 Hz
Power Adapter Output	12 VDC
Monitor Input	12 VDC, 2.5 A
Power Consumption	~ 20 W
Power Consumption (Standby mode)	DPMS, < 5 W

Environmental	
Operating Temperature	0° to 50°C (32° to 122°F)
Storage Temperature	-20° to 60°C (-4° to 140°F)
Humidity	20% to 90% non-condensing
Operating Shock	15 g, 6 msec, half-sine
Operating Vibration (sine)	1.0g, swept sine 9 – 500 Hz
Transport Vibration (random)	0.1g ² / Hz, 10 – 200 Hz 0.03g ² / Hz, 200 – 2000 Hz
Altitude	<ul style="list-style-type: none"> • Operating: up to 10,000 feet • Non-operating: up to 40,000 feet

Functional	
Control Panel Buttons	Left / Down, Right / Up, Menu, Power Indicator Light, Power
On-Screen Display (OSD) Menus	Brightness, Contrast, H. Position, V. Position, Phase, Clock, Auto Adjustment, OSD H. Position, OSD V. Position, Graphics Text, Recall, Language, Color Temperature, Save + Exit
Touch Screen Option	5-wire resistive system; emulates a mouse; Serial (RS-232) and USB interface to host computer

Physical	
Enclosure Type	Panel mount; rear collar compresses gasket against panel (5/16" maximum panel thickness); held by 8 M5 studs
Panel Rating (with proper installation)	Built to IP65/IP66 standards; NEMA/UL Type 12/4/4X
Depth Behind Panel	40.6 mm (1.6") maximum; 63.5 mm (2.5") at connectors
Front Bezel Outside Dimensions (W x H x D)	338.1 mm x 295.7 mm x 7.1 mm (13.31" x 11.64" x 0.28") (not including gasket)
Cutout Dimensions (W x H)	308 mm x 263 mm (12.12" x 10.35"); ± 0.5 mm (0.020")
Net Weight	9 lbs.
Shipping Weight	13 lbs.

Compliances and Certifications	
Electrical	<ul style="list-style-type: none"> • UL 1950 3rd Edition / cUL Recognized Component (File No. E212889) • UL 508A Listed (File No. E318630) • FCC Class A • CAN ICES-3A/NMB-3A • CE
Environmental	<ul style="list-style-type: none"> • IEC 60721-3 (Reliability) • WEEE (Registration No. WEE/DJ1859ZX for UK only)
Enclosure	UL 50E Type 12/4/4X (File No. E318630)

Warranty Statement

Who is Covered?

This warranty covers the purchaser of this product only and is not transferable without our written consent.

What Does This Warranty Cover and What is the Period of Coverage?

We warrant this product to be free from defects in material and workmanship, subject to the conditions set forth below. The warranty on all industrial display products, KB-R2 and KB-M2 keyboard series, KVM2 extender series, and ENCL-TC and ENCL-PC enclosure series remains in force for a three year period beginning on the date we invoice you. The warranty period on KB-PL1 keyboards is two years, and all other keyboards carry a one year warranty. If Hope Industrial Systems repairs or replaces a product under warranty, its warranty term is not extended.

What Will We Do to Correct Problems and How Do You Get Service?

We will repair or replace (at our sole option) any part of the unit which proves to be defective. Replacement parts may be new or refurbished and will meet the same specifications of the original parts or unit. For orders sold through our U.S. operations, at our expense we will return the product to any location within the U.S.A. via the shipping method of our choice. Shipping fees for products returned to customers outside the U.S.A. are the responsibility of the customer. For products originally sold through Hope Industrial U.K., return shipping to and from Hope Industrial repair facilities and any EU member country (except Croatia, Cyprus, and Malta) will be provided using a pre-paid UPS shipping label sent via email. In order to receive warranty service you must get prior approval from Hope Industrial Systems. To request warranty service you can telephone us at +1 678 762 9790 or +44 (0) 20 7193 2618 in the United Kingdom or send an email to support@HopeIndustrial.com. If we determine that warranty service is needed we will give you a Return Material Authorization (RMA) number. This RMA number must be conspicuously marked on the outside of the shipping box. Hope Industrial Systems will not accept shipments not accompanied by the RMA number. Except where otherwise noted, you must ship or deliver the product to Hope Industrial Systems Freight prepaid.

What Does This Warranty Not Cover?

This warranty does not cover equipment which has been damaged due to misuse, abuse, or accident such as: operating the equipment outside of published specifications; exposure to chemicals or gases not covered by specified NEMA standards; displaying fixed images for long periods of time resulting in afterimage effects; improper or unauthorized repair by anyone other than Hope Industrial Systems or a service agency authorized by Hope Industrial Systems to perform such repairs; fire, flood, "acts of God", or other contingencies beyond the control of Hope Industrial Systems.

Hope Industrial Systems' responsibility for malfunctions and defects in hardware is limited to repair and replacement as set forth in this warranty statement. Hope Industrial Systems shall not be liable for direct, indirect, incidental, consequential, or other types of damages resulting from the use of any Hope Industrial Systems product other than the liability stated above. These warranties are in lieu of all other warranties express or implied, including, but not limited to, the implied warranties of merchantability or fitness for a particular purpose. Some states do not allow the exclusion of implied warranties or the limitation or exclusion of liability for incidental or consequential damages so the above exclusions or limitations may not apply to you. You are cautioned that the performance of this product can be affected by many factors, such as system configuration, software, application, and operator control of the system. It is your responsibility to determine suitability of this product for your purpose and application.

Hope Industrial Systems, Inc.

US / International

1325 Northmeadow Parkway
Suite 100
Roswell, GA 30076
United States

Toll Free: (877) 762-9790
International: +1 (678) 762-9790
Fax: +1 (678) 762-9789

Sales and Customer Service: sales@HopeIndustrial.com
Support and Returns: support@HopeIndustrial.com
Accounting Department: accounting@HopeIndustrial.com
www.HopeIndustrial.com

United Kingdom

Harling Road
Snetterton
Norwich
NR16 2JU
United Kingdom

Phone: +44 (0) 20 7193 2618
Fax: +44 (0) 20 7117 1194

Sales and Customer Service: sales@HopeIndustrial.co.uk
Support and Returns: support@HopeIndustrial.co.uk
Accounting Department: accounting@HopeIndustrial.co.uk
www.HopeIndustrial.co.uk

