

Top View

Side View

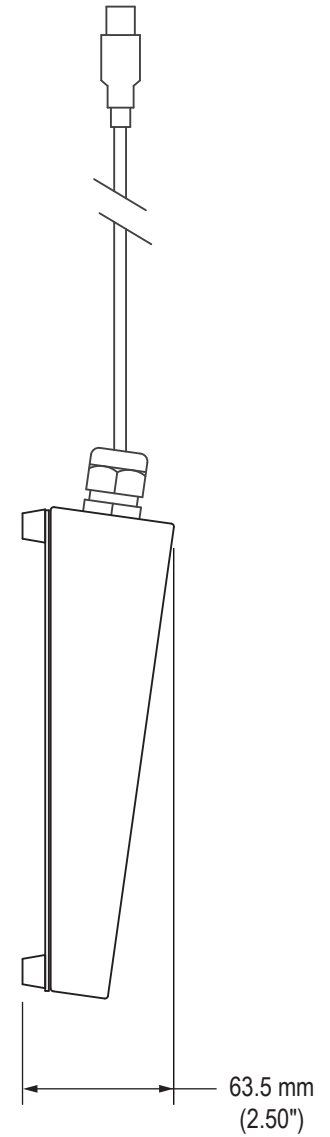

Detailed Top View Showing Keys

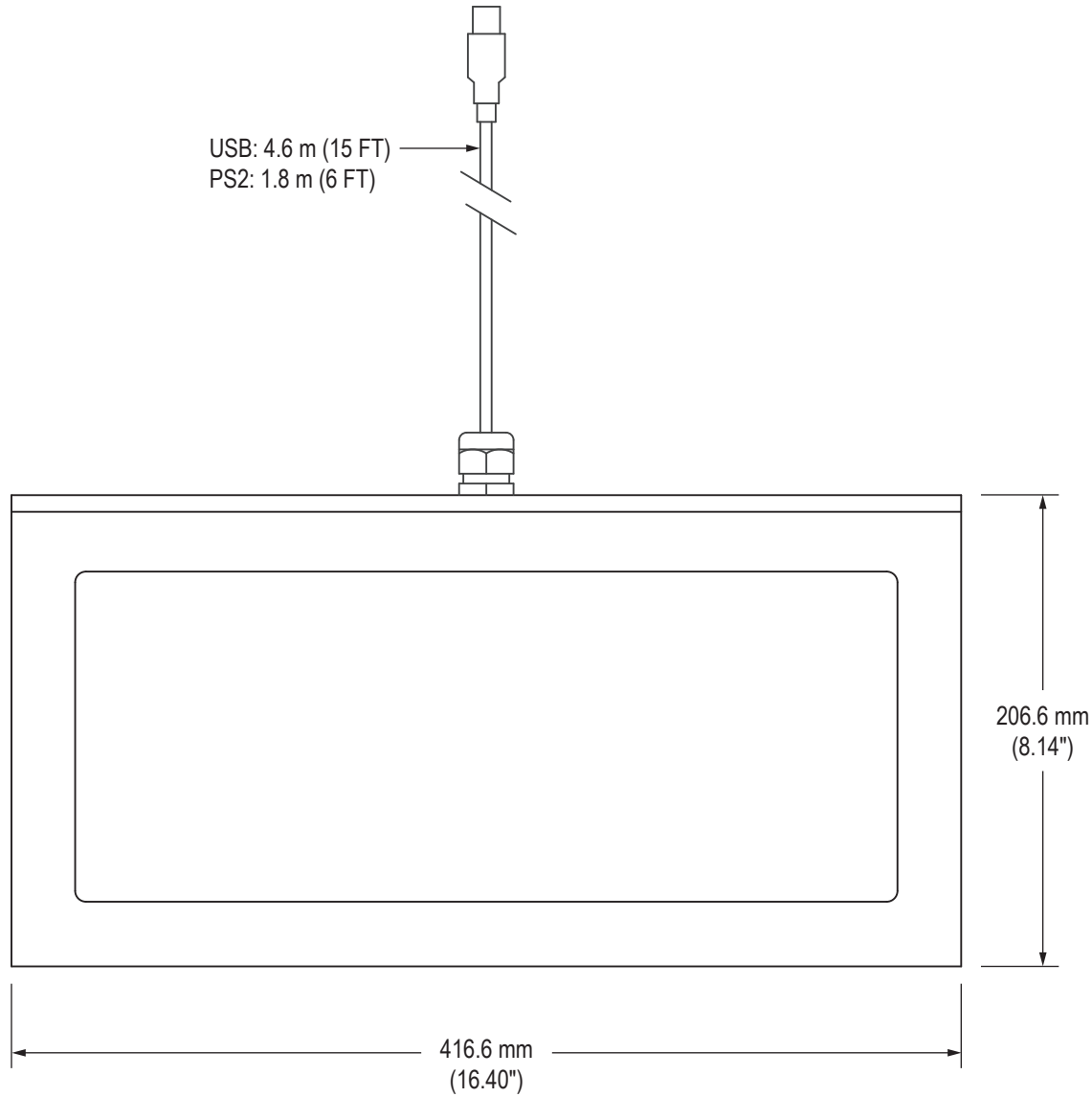
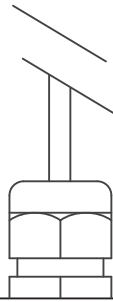

206.6 mm
(8.14")

416.6 mm
(16.40")

Mechanical Drawing – Full-Travel Benchtop Keyboard with Button Pointer

© 2018



Hope Industrial Systems, Inc.
 Toll Free: (877) 762-9790 · International: +1 (678) 762-9790
 UK: +44 (0) 20 7193 2618 · E-mail: support@HopeIndustrial.com

Part Number: KB-R2-BCH series
 Revision:

Date: 2012.04.16
 Page 2 of 2

NOTES: